

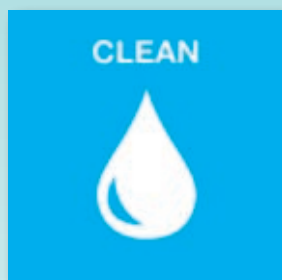

United States  
Department of  
Agriculture

# Kitchen Companion



*Your Safe Food Handbook*





# Kitchen Companion

*Your Safe Food Handbook*

“Food safety.” You hear a lot about it. But as with any comprehensive topic, there may be simple steps that are second nature that you’ve practiced forever — like hand washing — and then there may be current or updated information that is less familiar, or that may have changed since the last time you looked.

That’s what **Kitchen Companion: Your Safe Food Handbook** is all about. This food safety handbook contains all the basic information you need to know about food safety: some old and some new and all in one place.

Between the information-rich chapters and the easy index in the back, **Kitchen Companion** will likely answer all of your food safety questions. But if not, don’t miss the food safety contact information on page 44. The USDA’s Food Safety and Inspection Service is always there to help.



## *A Special Note to Those “At Risk”*

Some people are at higher risk for developing foodborne illness. These include pregnant women and their unborn babies, newborns, young children, older adults, and people with weakened immune systems.

If you — or someone you care for — are in one of these at-risk groups, it’s important to pay extra attention to handling food safely. For more on those at risk, visit [www.fsis.usda.gov](http://www.fsis.usda.gov).



## *About USDA’s Food Safety and Inspection Service (FSIS)*

FSIS is the public health agency within the U.S. Department of Agriculture that is responsible for ensuring that the Nation’s commercial supply of meat, poultry, and processed egg products is safe, wholesome, and correctly labeled and packaged.

FSIS focuses on inspecting and protecting the U.S. food supply and educating consumers about safe food handling and reducing the risks of foodborne illness.

Visit FSIS online at [www.fsis.usda.gov](http://www.fsis.usda.gov).



# table of contents

## Foodborne Bacteria

|                                     |       |
|-------------------------------------|-------|
| Spoilage Bacteria . . . . .         | 4     |
| Pathogenic Bacteria . . . . .       | 4     |
| Major Foodborne Pathogens . . . . . | 6 - 7 |

## Shopping for Food

|                                      |    |
|--------------------------------------|----|
| At the Store . . . . .               | 8  |
| Cross-Contamination . . . . .        | 8  |
| Transporting Groceries . . . . .     | 9  |
| Focus on: The "Danger Zone". . . . . | 9  |
| About Food Labels . . . . .          | 10 |

## Storing Food

|  |    |
|--|----|
| Refrigerated Perishable Food . . . . . | 11 |
| Frozen Food . . . . .                  | 12 |
| Cold Storage Chart . . . . .           | 13 |
| Shelf-Stable Food . . . . .            | 14 |

## Food Preparation

|  |    |
|--|----|
| Keeping It Clean . . . . .             | 15 |
| Preparation Tips for Produce . . . . . | 16 |
| Thawing . . . . .                      | 16 |

## Cooking Food Safely

|   |    |
|---|----|
| About Food Thermometers . . . . .                         | 17 |
| How to Use a<br>Food Thermometer . . . . .                | 17 |
| Food Thermometers and<br>Temperature Indicators . . . . . | 18 |
| Done Versus Safe . . . . .                                | 18 |
| Safe Minimum Internal<br>Temperature Chart . . . . .      | 19 |
| Avoid the "Danger Zone" . . . . .                         | 19 |

## Special Guidelines for Certain Food

|                                   |         |
|-----------------------------------|---------|
| Ground Meat and Poultry . . . . . | 20      |
| Ham . . . . .                     | 20      |
| Roasts . . . . .                  | 21      |
| Roasting Chart . . . . .          | 22 - 23 |

|                                      |         |
|--------------------------------------|---------|
| Turkey . . . . .                     | 24 - 26 |
| Chicken . . . . .                    | 27      |
| Eggs and Egg-Rich Food . . . . .     | 28      |
| Egg Storage Chart . . . . .          | 29      |
| Hot Dogs and Luncheon Meat . . . . . | 30      |
| Leftovers . . . . .                  | 30      |

## Specific Preparation and Cooking Methods

|                                   |    |
|-----------------------------------|----|
| Marinating . . . . .              | 31 |
| Microwave Cooking . . . . .       | 31 |
| Grilling and Barbecuing . . . . . | 32 |
| Smoking . . . . .                 | 33 |
| Slow Cooking . . . . .            | 34 |

## Serving Food Safely

|                                       |    |
|---------------------------------------|----|
| General Guidelines . . . . .          | 35 |
| Buffets . . . . .                     | 36 |
| Take-Out and Delivered Food . . . . . | 37 |

## Transporting Food

|                       |    |
|-----------------------|----|
| Bag Lunches . . . . . | 38 |
| Coolers . . . . .     | 39 |

## Food Safety for Food-by-Mail

|                           |    |
|---------------------------|----|
| Mail-Order Food . . . . . | 40 |
|---------------------------|----|

## Food Safety in an Emergency

|                         |    |
|-------------------------|----|
| Power Outages . . . . . | 41 |
| Floods . . . . .        | 41 |
| Fires . . . . .         | 42 |

## Food Product Recalls

|                           |    |
|---------------------------|----|
| Product Recalls . . . . . | 43 |
| "Ask Karen". . . . .      | 43 |

## Food Safety Contacts

|                                       |    |
|---------------------------------------|----|
| USDA Meat & Poultry Hotline . . . . . | 44 |
| For More Information . . . . .        | 44 |

## Index . . . . .

### *Four Steps to Keep Your Family Safer from Food Poisoning*



Clean



Separate



Cook



Chill



# foodborne bacteria

*There are two kinds of foodborne bacteria: one that spoils your food and one that makes you sick. It's good to be familiar with both, but it's critical that you follow safe food handling practices to keep the second one at bay.*

## Spoilage Bacteria

Spoilage bacteria cause food to go bad — in other words, to “spoil.” With spoilage bacteria, the food looks or smells funny or bad, so you know to throw it out. These bacteria can grow at lower temperatures — even in the refrigerator. But while they can make food unappealing and inedible, they do **not** usually cause illness.

## Pathogenic Bacteria

These are the ones you need to watch out for; in fact, it's pathogenic bacteria and the toxins or poisons they produce that the food safety precautions

throughout this handbook are intended to prevent. You can't see, smell, or taste these pathogens, and this makes them difficult to detect. What's more, they cause a variety of foodborne illnesses and can make you really, really sick.

## Pathogenic Bacteria: The Cause of Foodborne Illness

Pathogenic bacteria cause illness, and they can get in food in a number of ways. Sometimes these bacteria occur naturally and are destroyed by cooking food to safe temperatures. Pathogenic bacteria can also end up contaminating food when proper guidelines for cleaning hands, surfaces, and utensils and for avoiding cross-contamination are not followed.

- Different bacteria are present in different foods, and some are more common in certain situations.

## Foodborne Illness

Often called “food poisoning,” foodborne illness comes from a food you eat. It's caused by ingesting **pathogenic bacteria** or the poisons they produce.

## *Foodborne Illness in the United States*

The food supply in the United States is safe, but it can still be a source of infection for everyone. When certain disease-causing bacteria or pathogens contaminate food, they can cause foodborne illness.

According to the Centers for Disease Control and Prevention, 48 million persons get sick, 128,000 are hospitalized, and 3,000 die from foodborne infection and illness in the United States each year. Many of these people are children or older adults or have weakened immune systems and may not be able to fight infection normally.

Since foodborne illness can be serious — or even fatal, it is important for you to know and practice safe food handling behaviors to help reduce your risk of accidentally getting sick from contaminated food.

For example, *Salmonella* is most often found in poultry or eggs, whereas *E. coli* is more typically found in or on meats and vegetables. Meanwhile, *Staphylococcus aureus* and *Clostridium perfringens* are frequently present on people's hands and even in buffet lines.

- Throughout this handbook, you'll find effective strategies for preventing illness from pathogenic bacteria. Food safety is extremely important and should be practiced with every meal you eat or prepare. The **Major Pathogens** chart (on pages 6-7) gives greater detail regarding the most common foodborne bacteria, where they are found, and what they can do if ingested.

### About Mold on Food

**Molds** are *not* bacteria. To learn about mold on food, read the fact sheet "Molds on Food: Are They Dangerous?" at [www.fsis.usda.gov](http://www.fsis.usda.gov).



## Foodborne Illness: Know the Signs and Symptoms . . . and Take Action

The signs and symptoms of foodborne illness range from upset stomach, diarrhea, fever, vomiting, abdominal cramps, and dehydration to more severe illness—even death. If you become ill and believe your illness is due to a food product:

- **Seek treatment as necessary.**  
Contact your doctor—especially if symptoms persist or become severe (bloody diarrhea, excessive nausea and vomiting, or high fever). For victims in an at-risk group (pregnant women and their unborn babies, newborns, young children, older adults, and people with weakened immune systems), seek medical care immediately.
- **Preserve the evidence** if a portion of the suspect food is available.
- **Call your local health department** if the suspect food was served at a large gathering, or at a restaurant or other food service facility.
- **Call the USDA Meat and Poultry Hotline** at 1-888-MPHotline (1-888-674-6854) if the suspect food is a USDA-inspected product and you have all the packaging.
- **Report complaints online** to USDA's Consumer Complaint Monitoring System (CCMS). Go to "**Report a Problem with Food**" at [www.fsis.usda.gov](http://www.fsis.usda.gov)

## Major Pathogens That Cause Foodborne Illness (Bacteria and Parasites)

| Pathogen  | Methods of Transmission  | Symptoms and Potential Impact  |
|---|--|--|
| <b><i>Campylobacter jejuni</i></b>  | <ul style="list-style-type: none"> <li>• Untreated or contaminated water</li> <li>• Unpasteurized (“raw”) milk</li> <li>• Raw or undercooked meat, poultry, or shellfish</li> </ul>  | <ul style="list-style-type: none"> <li>• Fever, headache, and muscle pain followed by diarrhea (sometimes bloody), abdominal pain, and nausea. Symptoms appear 2 to 5 days after eating and may last 2 to 10 days. May spread to the bloodstream and cause a life-threatening infection.</li> </ul>  |
| <b><i>Clostridium botulinum</i></b>   | <ul style="list-style-type: none"> <li>• Improperly canned foods</li> <li>• Garlic in oil</li> <li>• Vacuum-packed and tightly wrapped food</li> </ul>   | <ul style="list-style-type: none"> <li>• Bacteria produce a nerve toxin that causes illness, affecting the nervous system. Symptoms usually appear in 18 to 36 hour, but sometimes in 6 hours to 10 days: double or blurred vision, drooping eyelids, slurred speech, difficulty swallowing, dry mouth, and muscle weakness. If untreated, can lead to muscle paralysis and even death.</li> </ul>   |
| <b><i>Clostridium perfringens</i></b>   | <ul style="list-style-type: none"> <li>• Many outbreaks result from food left for long periods on steam tables or at room temperature and time and/or temperature abused foods.</li> <li>• Meats, meat products, poultry, poultry products, and gravy</li> </ul> | <ul style="list-style-type: none"> <li>• Onset of watery diarrhea and abdominal cramps within about 16 hours. The illness usually begins suddenly and lasts for 12 to 24 hours. In the elderly, symptoms may last 1 to 2 weeks.</li> <li>• Complications and/or death occur rarely.</li> </ul>   |
| <b><i>Escherichia coli</i> O157:H7</b><br>One of several strains of <i>E. coli</i> that can cause human illness | <ul style="list-style-type: none"> <li>• Undercooked beef, especially hamburger</li> <li>• Unpasteurized milk and juices, like “fresh” apple cider</li> <li>• Contaminated raw fruits and vegetables, and water</li> <li>• Person-to-person contact</li> </ul>   | <ul style="list-style-type: none"> <li>• Severe diarrhea that is often bloody, abdominal cramps, and vomiting. Usually little or no fever.</li> <li>• Can begin 1 to 9 days after contaminated food is eaten and lasts about 2 to 9 days.</li> <li>• Some, especially the very young, may develop hemolytic-uremic syndrome (HUS), which can cause acute kidney failure, and can lead to permanent kidney damage or even death.</li> </ul> |
| <b><i>Listeria monocytogenes</i></b><br>Can grow slowly at refrigerator temperatures                            | <ul style="list-style-type: none"> <li>• Hot dogs, luncheon meats, cold cuts, fermented or dry sausage, and other deli-style meat and poultry</li> <li>• Unpasteurized (raw) milk and soft cheeses made with unpasteurized (raw) milk</li> </ul>                 | <ul style="list-style-type: none"> <li>• Fever, chills, headache, backache, sometimes upset stomach, abdominal pain, and diarrhea. May take up to 2 months to become ill. The duration is variable.</li> <li>• Gastrointestinal symptoms may appear within a few hours to 2 to 3 days, and disease may appear 2 to 6 weeks after ingestion.</li> </ul>   |



|   |  |   |
|---|--|---|
|   | <ul style="list-style-type: none"> <li>Smoked seafood and salads made in the store, such as ham salad, chicken salad, or seafood salads</li> <li>Raw vegetables</li> </ul>   | <ul style="list-style-type: none"> <li>Those at-risk (including people with cancer and others with weakened immune systems) may later develop more serious illness; death can result from this bacteria.</li> <li>Can cause problems with pregnancy, including miscarriage, fetal death, or severe illness or death in newborns.</li> </ul>   |
| <p><b>Salmonella</b><br/>(over 2,300 types)</p> | <ul style="list-style-type: none"> <li>Raw or undercooked eggs, poultry, and meat</li> <li>Unpasteurized (raw) milk or juice</li> <li>Cheese and seafood</li> <li>Fresh fruits and vegetables</li> </ul>   | <ul style="list-style-type: none"> <li>Stomach pain, diarrhea (can be bloody), nausea, chills, fever, and/or headache usually appear 6 to 72 hours after eating; may last 4 to 7 days.</li> <li>In people with a weakened immune system, such as people with cancer, the infection may be more severe and lead to serious complications, including death.</li> </ul>  |
| <p><b>Staphylococcus aureus</b></p>             | <ul style="list-style-type: none"> <li>Contaminated milk and cheeses</li> <li>Salty foods, e.g., ham</li> <li>Sliced meat</li> <li>Food made by hand that require no reheating; e.g., puddings, sandwiches</li> <li>Foodworkers who carry the bacteria and contaminate food</li> </ul> | <ul style="list-style-type: none"> <li>Nausea, vomiting, stomach cramps, and diarrhea usually occur within 30 minutes to 6 hours after eating contaminated food.</li> <li>Symptoms typically last 1 to 3 days; the young and the elderly may have a more severe illness.</li> </ul>   |
| <p><b>Toxoplasma gondii</b></p>                 | <ul style="list-style-type: none"> <li>Accidental contact of cat feces through touching hands to mouth after gardening, handling cats, cleaning cat's litter box, or touching anything that has come in contact with cat feces.</li> <li>Raw or undercooked meat.</li> </ul>           | <ul style="list-style-type: none"> <li>Flu-like illness that usually appears 10 to 13 days after eating; may last months. Those with a weakened immune system, including people with cancer, may develop more serious illness.</li> <li>Can cause problems with pregnancy, including miscarriage and birth defects.</li> </ul>  |
| <p><b>Trichinella spiralis</b></p>              | <ul style="list-style-type: none"> <li>People get trichinellosis (trichinosis) by consuming raw or undercooked meats such as pork, wild boar, bear, bobcat, cougar, fox, wolf, seal, or walrus infected with <i>Trichinella</i> larvae.</li> </ul>                                     | <ul style="list-style-type: none"> <li>Abdominal symptoms may appear within 1 to 2 days after eating contaminated meat. The first symptoms are nausea, diarrhea, vomiting, fever, fatigue, and abdominal pain, followed by headaches, eye swelling, aching joints and muscles, weakness, and itchy skin. Further symptoms (eye swelling and aching muscles and joints) may begin 2 to 8 weeks after infection.</li> </ul> |



# shopping for food

*For consumers, food safety most likely begins in the supermarket aisle. Whether you're doing a quick trip to pick up dinner ingredients or tackling a week's worth of grocery shopping all at once, there are a few easy steps you can follow to ensure that the food you bring home will arrive there safely.*

## At the Store

- **Select cold food last.** Picking up perishable food like meat, poultry, and eggs at the end of your shopping trip ensures that they stay refrigerated until right before checkout.
- **Read the label.** Don't buy food that is past the "Sell-By," "Use-By," or other expiration dates. (See *About Food Labels* on page 10.)
- **Check the packaging.** Never choose meat or poultry with packaging that is torn or leaking. Make sure frozen food is frozen solid and refrigerated food feels cold.
- **Buy clean eggs.** At the store, choose refrigerated Grade A or AA eggs with clean, uncracked shells before the "Sell-By" or "EXP" (expiration) date on the carton. When purchasing egg products or substitutes, look for containers that are tightly sealed.
- **Inspect fresh produce.** Don't buy fresh fruits or vegetables that are bruised or damaged. Make sure fresh-cut fruits and vegetables are displayed in refrigerated cases at the store. If not, don't buy them.
- **Place meat, poultry, and seafood in plastic bags.** By bagging these foods *before* placing them in your cart, you'll guard against cross-contamination

## Cross-Contamination

Cross-contamination is the transfer of harmful bacteria to a food from other foods, cutting boards, utensils, surfaces, or hands.

It is prevented by keeping food separated and by keeping hands, utensils, and food handling surfaces clean.



— which can happen when raw meat or poultry juices drip on other food, spreading bacteria from one food to another.

- **Separate foods in your grocery cart.** Keep raw meat, poultry, seafood, and their juices away from other food to further prevent the possibility of cross-contamination. Keep them separated during checkout and in your grocery bags, too.

## Transporting Groceries

Once your groceries are packed for the trek home, there are some easy “timing” tips you should follow to continue to maintain their safety.

- **Go straight home.** Plan to drive directly home from the grocery store. Don't leave groceries in the car while you run other errands. The key is to **always refrigerate perishable food within 2 hours**. This is true of all perishable food and in all situations and is known as the “2-Hour Rule.”
- **Do a “Weather Check.”** When the outside temperature is above 90 °F (32.2 °C), you should refrigerate your purchased perishables more quickly — **within 1 hour**. If your grocery store is more than a half hour away from home, bring a cooler when you go shopping. Pack your meat, poultry, seafood, and eggs in a cooler for the drive home.

### Focus on: The “Danger Zone”

Throughout the **Kitchen Companion**, there are references to keeping food out of the “Danger Zone.” Understanding the “Danger Zone” is critical because bacteria can multiply rapidly in any perishable food that is left in the “Danger Zone” between 40 and 140 °F (4.4 and 60 °C) for more than 2 hours (1 hour if above 90 °F or 32.2 °C). (See Remember the 2-Hour Rule on page 35.) The “Danger Zone” is a potential risk for cold food that goes above 40 °F (4.4 °C) and hot food that falls below 140 °F (60 °C). However, it's easy to avoid the “Danger Zone”: just keep hot food hot and cold food cold!

## Arriving Home

When you get home, don't get caught up reading the mail! Unload your groceries right away to keep them safe, and refrigerate or freeze all perishables.

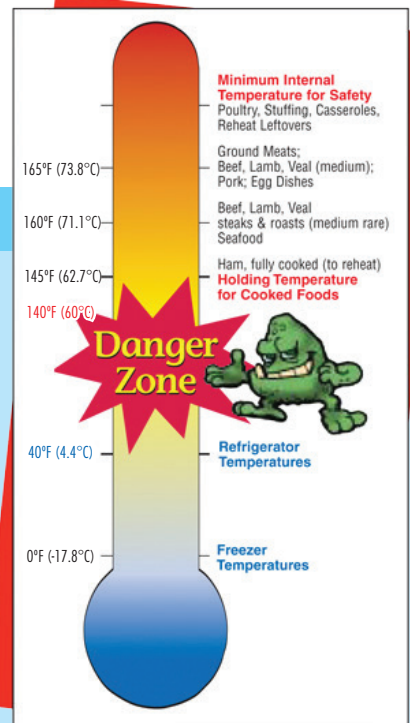

## About Food Labels

### Product Dating

Except for infant formula, food product dating is not generally required by Federal regulations. However, dating of some foods is required by more than 20 states. Here's what the dates mean.

**“Sell By” date:** Tells the store how long to display the product for sale. You should buy the product before the date expires.



**“Best If Used By” (or Before) date:** Recommended for best flavor or quality. It is *not* a purchase or safety date.



**“Use-By” date:** The last recommended date for the use of the product while at peak quality. The date has been determined by the product's manufacturer.

**Closed or Coded dates:** Packing numbers for use by the manufacturer. If a product is not “dated,” consume perishable food by the times on page 13.

### What is “Organic”?

- **Organic meat, poultry, eggs, and dairy products** come from animals that are given no antibiotics or growth hormones and must meet many other criteria to comply with USDA organic standards.
- **For more information about the National Organic Program,** visit USDA's Agricultural Marketing Service at [www.ams.usda.gov/AMSV1.0/nop](http://www.ams.usda.gov/AMSV1.0/nop).



### Ready to Eat—or Not?

Check labels carefully. Some products may appear to be precooked or browned but are raw and not ready to eat. Cook these foods to the safe minimum internal temperature of 165 °F (73.9 °C). Unless a product is labeled as “fully cooked,” the food should be handled and prepared no differently than raw products.



### Safe Handling Instructions

These guidelines on raw meat and poultry provide specific information for handling and preparation. Following these instructions is particularly important for consumers in at-risk groups.



All containers of meat, poultry, and egg products must be labeled with the USDA mark of inspection and the plant's establishment (EST) number. The numbers following EST (or P for poultry) tell where the product was made.

# storing food

*The food you store falls into three basic “storage categories.”*

- **Perishable food:** in the refrigerator (read the label if you’re not sure)
- **Frozen food:** in the freezer
- **Shelf-stable food:** in a clean, dry place

## Refrigerated Perishable Food

Food safety is the best reason ever to “chill out”! Follow these basic guidelines to protect your perishables — **and** yourself and your family. And remember: always refrigerate perishable food within 2 hours—1 hour when the temperature is above 90 °F (32.2 °C).

- **Raw Meat, Poultry, and Seafood:** Place in containers or sealed plastic bags to prevent their juices from dripping onto other food in the refrigerator. This could cause cross-contamination (see inset box, page 8). If you’re not planning to use the food within a day or two, freeze it.
- **Cooked, Whole Stuffed Poultry:** Remove stuffing and refrigerate it in a separate covered container.
- **Eggs:** Store in the original carton and place in the main compartment of the refrigerator — not in the door. When ready to use, do not wash them. (Read more about *Eggs* on page 28.)
- **Produce:** Store perishable produce in the refrigerator. Throw away fresh fruits and vegetables that have not been refrigerated within 2 hours of cutting, peeling, or cooking.

## It’s a Date!

- As you store your food, **check dates** on the labels.
  - If a product does not have a date on it, **write the purchase date on it** before you refrigerate or freeze it.
  - Place newer items in the back of the refrigerator or freezer. That way, you’ll **use the older ones first.**
- 
- **Leftovers:** Refrigerate (or freeze) leftovers within 2 hours after cooking in clean, shallow, covered containers to prevent harmful bacteria from multiplying. (See more on *Leftovers* on page 30.)



## Frozen Food

For long-term storage of many perishable foods, rely on the freezer. Food stored constantly at 0 °F (-17.8 °C) or below will always be safe. Only the quality suffers with lengthy freezer storage.

### Freezer Facts

- **Preventing Freezer Burn:** Freezer burn — white, dried-out patches on the surface of meat — won't make you sick, but it *does* make meat tough and tasteless. Here's how to avoid it:
  - Wrap freezer items in heavy freezer paper, plastic wrap, or foil.
  - Date all freezer packages. Use the oldest food first.
  - Place new items toward the back of the freezer; that way, older items are easier to access and you'll use them first.
- **Refreezing Thawed Food:** If food is thawed in the refrigerator, it is safe to refreeze it without cooking.
- **Freezing Cooked Food:** After cooking raw food that was previously frozen, it is safe to freeze the cooked food. In addition, if previously cooked food was frozen and then thawed in the refrigerator, you may refreeze the unused portion.
- **Prevent Moisture Loss:** To maintain quality when freezing meat and poultry in its original packaging, overwrap the package with foil or plastic wrap that is recommended for use in the freezer.



(See *Thawing* section on page 16.)

However, there may be a loss of *quality* because of the moisture lost through defrosting.

## Your Refrigerator and Freezer: Take Their Temperatures!

It's common to assume that your refrigerator's temperature control dial keeps food cold enough, but this isn't necessarily true. "Built-in" temperature control dials may not be effective, and if your refrigerator isn't cooling to 40 °F (4.4 °C) or below, you're providing a haven for bacteria to grow.

- Instead, use a separate appliance thermometer to check the internal refrigerator temperature and help keep food safe. They are available in grocery, hardware, and kitchen specialty stores.
- If the refrigerator thermometer shows a temperature that's too high (above 40 °F/4.4 °C), adjust the refrigerator's control dial.
- Use the thermometer to check the freezer, too. It should read 0 °F (-17.8 °C) or below. If not, adjust the dial.

## Cold Storage Chart

| Product  | Refrigerator<br>(40 °F/4.4 °C) | Freezer<br>(0 °F/-17.8 °C) |
|--|--------------------------------|----------------------------|
| <b>Eggs</b> — See Page 29  |                                |                            |
| <b>Salads</b>  |                                |                            |
| Egg, chicken, ham, tuna & macaroni salads                            | 3 to 5 days                    | Does not freeze well       |
| <b>Hot dogs</b>  |                                |                            |
| Opened package   | 1 week                         | 1 to 2 months              |
| Unopened package   | 2 weeks                        | 1 to 2 months              |
| <b>Luncheon meat</b>   |                                |                            |
| Opened package or deli sliced  | 3 to 5 days                    | 1 to 2 months              |
| Unopened package   | 2 weeks                        | 1 to 2 months              |
| <b>Bacon &amp; Sausage</b>   |                                |                            |
| Bacon  | 7 days                         | 1 month                    |
| Sausage, raw — from chicken, turkey, pork, beef                      | 1 to 2 days                    | 1 to 2 months              |
| <b>Hamburger &amp; Other Ground Meats</b>                            |                                |                            |
| Hamburger, ground beef, turkey, veal, pork, lamb, & mixtures of them | 1 to 2 days                    | 3 to 4 months              |
| <b>Fresh Beef, Veal, Lamb &amp; Pork</b>                             |                                |                            |
| Steaks   | 3 to 5 days                    | 6 to 12 months             |
| Chops  | 3 to 5 days                    | 4 to 6 months              |
| Roasts   | 3 to 5 days                    | 4 to 12 months             |
| <b>Fresh Poultry</b>   |                                |                            |
| Chicken or turkey, whole   | 1 to 2 days                    | 1 year                     |
| Chicken or turkey, pieces  | 1 to 2 days                    | 9 months                   |
| <b>Soups &amp; Stews</b>   |                                |                            |
| Vegetable or meat added  | 3 to 4 days                    | 2 to 3 months              |
| <b>Leftovers</b>   |                                |                            |
| Cooked meat or poultry   | 3 to 4 days                    | 2 to 6 months              |
| Chicken nuggets or patties   | 3 to 4 days                    | 1 to 3 months              |
| Pizza  | 3 to 4 days                    | 1 to 2 months              |

## Shelf-Stable Food

Food that doesn't need to be refrigerated or frozen must still be stored with care. Follow these basic guidelines and you'll have food safety in the bag (or can)!

- **Where:** Store canned food and other shelf-stable products in a cool, clean, dry place. Never put them above the stove, under the sink, in a damp garage or basement, or any place exposed to high or low temperature extremes.
- **How Long:** In general, you can store high-acid food, such as tomatoes and other fruit, for 12 to 18 months; low-acid food, such as meat and vegetables, 2 to 5 years.
- **Care and Cautions for Cans:** Discard cans that are dented, leaking, bulging, or rusted. Can linings might discolor or corrode when metal reacts with high-acid food, such as tomatoes or pineapple, but as long as the outside of the can is in good shape, the contents should be safe to eat. Keep in mind, though, that the taste, texture, and nutritional value of the food can diminish over time. (Also see *Floods* on page 41.)



## Botulism Alert

The greatest danger in canned goods is a toxin produced by the *Clostridium botulinum* bacteria. Never use food from containers that show possible “botulism” warnings:

- Leaking, bulging, or badly dented cans
- Cracked jars or jars with loose or bulging lids
- Canned food with a foul odor
- Any container that spurts liquid or foam when opened.

Play it safe — and never taste it. Even a tiny amount of *botulinum* toxin can be deadly.

Double bag the cans and jars in plastic bags that are tightly closed. Then place in a trash receptacle for non-recyclable trash outside of the home. Keep out of reach of humans and pets.

## Common Sense Caution

If you're not sure how old a food is, or fear that it may not have been properly refrigerated or has been left out too long, don't taste it! Instead, remember the “golden rule” of food storage:

*When in doubt, throw it out!*



# food preparation

*Food safety doesn't end with buying, transporting, and storing food safely. In fact, once you have food home, the safety of your food is, literally, in your hands. Follow these basic guidelines — and remember, safe food preparation always begins with “clean.”*

## Keeping It Clean

### Handwashing

- Always wash hands with soap and warm water for 20 seconds before beginning food preparation, after handling food, and after using the bathroom, changing diapers, or touching pets.
- Use disposable gloves to handle food if you have a cut or infection. Do not sneeze or cough into food.

### Surfaces and Utensils

Harmful bacteria can spread throughout the kitchen and get onto cutting boards, utensils, and countertops causing “cross-contamination.” (See inset box on page 8.) Keep raw meat, poultry, fish, and their juices away from other food — especially ready-to-eat food.

- Wash cutting boards, dishes, and countertops with hot, soapy water **after** preparing each food item and **before** you go on to the next item.
- After cutting raw meat, poultry, and seafood, wash cutting boards, knives, and countertops with hot, soapy water.

### Cutting Boards

Proper cutting board care is a key component of preventing cross-contamination. Here's how:

- Always use a clean cutting board for food preparation.
- Try to use one cutting board for fresh produce and a separate one for raw meat, poultry, and seafood.
- Sanitize cutting boards by rinsing with a solution of 1 tablespoon of unscented, liquid chlorine bleach in 1 gallon of water.
- Once cutting boards become excessively worn or develop hard-to-clean grooves, replace them.

### Kitchen Cleanup

- Use hot, soapy water and a clean dishcloth (or paper towels) to clean kitchen surfaces and wipe up spills.
- Wash dishcloths often in the hot cycle of your washing machine.



## Preparation Tips for Produce

Fresh fruits and veggies are nutritional mainstays. Here's how to make sure they're safe.

- Before eating or preparing, wash fresh produce under cold running tap water to remove any lingering dirt. This also reduces bacteria that may be present. Firm produce (like apples or potatoes) can be scrubbed with a brush.
- Don't wash fruits and vegetables with detergent or soap. These products are **not approved** for use on food. You could ingest residues from soap or detergent absorbed by the produce.
- Remove and throw away bruised or damaged portions of fruits and vegetables when preparing to cook them or before eating them raw.



## Thawing

Going from “frozen to thawed” needs to be accomplished safely! There are three ways to thaw — and because bacteria can multiply rapidly at room temperature, **none** of these methods involve the kitchen counter.

**In the Refrigerator:** This is the safest way to thaw meat and poultry. Take the food out of the freezer and thaw it in the fridge. Place it on a plate or in a pan to catch any juices that may leak. Normally, it will be thawed in a day or two, depending on its size.

**In Cold Water:** For faster thawing, put the frozen package in a watertight plastic bag and submerge it in cold water; change the water every 30 minutes. The cold water slows bacterial growth in the thawed portions of the meat while the inner areas are still thawing. Once thawed, cook it immediately.

**In the Microwave:** Follow instructions from the oven's manufacturer or owner's manual. Cook immediately after thawing in the microwave.

**NOTE:** Frozen meat and poultry can be cooked without thawing. Just add 50% to the cooking time.

## Refreezing Tips:

- Meat and poultry that have been fully defrosted in the refrigerator may be refrozen before **or** after cooking.
- If thawed in cold water or in the microwave, always fully cook before refreezing.

(Also see **Storing Food: Frozen Food** on page 12.)

# cooking food safely

*Cooking food to a safe temperature is the best way to ensure safety. That's because when food reaches a **safe minimum internal temperature**, bacteria that may be lurking are destroyed. Sound complicated? It's not. It's as easy as using a **food thermometer**.*

## About Food Thermometers

Food safety experts agree: food is safe to eat when it is cooked or reheated to a high enough temperature to kill the harmful bacteria that cause foodborne illness.

The only accurate way to know if food is cooked safely is to measure the internal temperature of cooked meat, poultry, and egg products with a food thermometer. You can't tell by looking — use a food thermometer to be sure. Color and texture are not reliable indicators of safely cooked food.



## How to Use a Food Thermometer

1. Place the food thermometer in the **thickest part of the food**.
  - Make sure it's not touching bone, fat, or gristle.
  - For whole poultry, check the internal temperature in the innermost part of the thigh and wing and the thickest part of the breast.
  - For combination dishes, place the thermometer in the center or thickest portion of the food. Egg dishes and dishes containing ground meat or poultry should be checked in several places.
2. Wait the amount of time recommended for your particular type of thermometer (See *Food Thermometers and Temperature Indicators* on page 18).
3. Compare your thermometer reading to the Safe Minimum Internal Temperature Chart (see page 19) to determine if your food has reached at least a safe internal temperature.
4. Clean your food thermometer with hot, soapy water before and after each use!

## Tasting Tips

- Don't taste food while it's cooking. To ensure safety, food should not be tasted until it reaches a safe minimum internal temperature.
- No double dipping. Use a clean utensil each time you taste food; otherwise, you may contaminate the batch.

## Food Thermometers and Temperature Indicators



### Dial Oven-Safe (Bimetal)

- Reads in 1 to 2 minutes
- Place 2 to 2½" deep in thickest part of food
- Best used in roasts, whole poultry, casseroles, and soups



### Digital Instant-Read (Thermistor)

- Reads in 10 seconds
- Place at least ½" deep
- Use in thin *and* thick food



### Dial Instant-Read (Bimetal)

- Reads in 15 to 20 seconds
- Place 2 to 2½" deep in thickest part of food



### Disposable Temperature Indicators (Single-use)

- Reads in 5 to 10 seconds
- Place approximately ½" deep (follow manufacturer's directions)

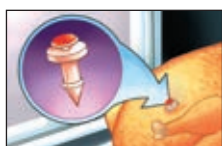

### Pop-Up

- Commonly used in turkeys and roasting chickens
- Pops up when food reaches final temperature for safety and doneness
- Recommendation: Use an additional food thermometer to check temperature in other parts of the food.

## Done Versus Safe: What You Need to Know

Webster's Dictionary defines "doneness" as *the condition of being cooked to the desired degree*. This includes subjective qualities, like a food's appearance, texture, and optimum flavor.

But whether a food is cooked to a "safe" degree is another story. The standard that ensures "safety" is not subjective at all. It's a simple matter of cooking food until the internal temperature reaches the level that ensures destruction of any potential pathogens, as measured with a food thermometer.

Visual signs of doneness should only be taken into consideration *after* the food has reached a safe temperature. And if you're thinking about leaving the food thermometer in the drawer, consider this: According to USDA research, **1 out of every 4** hamburgers turns brown *before* it reaches a safe internal temperature!



## Safe Minimum Internal Temperature Chart

*As measured with a food thermometer*

| Food  | °F (°C)   |
|---|---|
| Beef, Pork, Veal, and Lamb (roast, steaks, and chops) | 145 °F (62.8 °C) with a 3-minute "rest time" after removal from the heat source                               |
| Ground Meats  | 160 °F (71.1 °C)  |
| Poultry (whole, parts, or ground)                     | 165 °F (73.9 °C)  |
| Eggs and egg dishes                                   | 160 °F (71.1 °C)<br>Cook eggs until both the yolk and the white are firm. Scrambled eggs should not be runny. |
| Leftovers   | 165 °F (73.9 °C)  |
| Fin Fish  | 145 °F (62.8 °C)  |

*For oven roasting guidelines, see the roasting charts on pages 26 (turkey) and 22 (meats and other poultry).*

## Avoid the "Danger Zone"—Keep Hot Food Hot After Cooking

The possibility of bacterial growth is greater when food cools because the drop in temperature allows bacteria to thrive. There are two ways to keep cooked food from entering the "Danger Zone":

- **Don't Interrupt Cooking:**

Interrupted cooking allows partially cooked food to cool down . . . and may encourage bacterial growth before cooking is complete. To avoid this, make sure to cook food all the way through the first time.

- **Hold Hot Food at 140 °F (60 °C):**

If you aren't going to serve food right away, it's important to keep it at 140 °F (60 °C) or above. Once food is safely cooked on the stovetop, in the oven, or in a microwave oven, keep food hot by using a heat source. Place food in chafing dishes, on warming trays, or in slow cookers. Check the temperature frequently to make sure food stays at or above 140 °F (60 °C).

(Also see *Focus On: The "Danger Zone"* on page 9 and *Special Guidelines for Certain Food* beginning on page 20.)





# special guidelines for certain food

*In addition to the basic cooking guidelines (see *Cooking Food Safely* beginning on page 17) — there are some food-specific tips that can help you take special care with your culinary favorites.*

---

## Ground Meat and Poultry

Ground meat and poultry receive more handling than any other cut of meat or poultry. This means that hamburger has the opportunity for the introduction of more foodborne bacteria, too. Be diligent with general safe food handling guidelines, and keep these **buying tips** in mind:

- When you purchase ground beef, it should be **cherry-red** (or purple-red, if in vacuum packaging).
- **Return** any package that has an unusual odor when you open it.

---

## Ham

Even though it is **cured**—smoked ham, for example, can still contain foodborne bacteria. Follow these tips to keep it safe:

### Storing:

- **Refrigerator:**
  - Store all perishable ham in the refrigerator at **40 °F (4.4 °C) or below**. Country ham is shelf stable.
  - Use slices within 3 to 4 days; whole ham within a week.
  - Most canned hams should be refrigerated. Be sure to check the label!
  - Observe “Use-By” dates on hams sealed at the plant; use store-wrapped cooked ham portions within 3 to 5 days.
- **Freezer:** Ham tends to lose flavor and texture when frozen. If you do need to freeze it, wrap it tightly in freezer paper or plastic freezer bags and use it within 1 or 2 months.

### Cooking:

First and foremost, read the label.

- “Fully cooked” ham can be served “as is” — hot or cold. If reheating, cook to 140 °F (60 °C).
- Fresh ham (labeled “Cook before eating”) and other fresh pork must be cooked to 145 °F (62.8 °C) with a 3-minute rest time.



---

## Roasts

Sit-down dinners and special occasions aren't only about turkey! There are many other types of roasts that become the stars of the dinner table. Use these guidelines to “make the most of your roast” . . . safely.

### Cooking Your Roast

**Roasting** is the recommended method for cooking tender meats.

To roast, meat is placed on a rack in a shallow, uncovered pan and is cooked by the indirect, dry heat of an oven. To keep the meat tender and minimize shrinkage due to the evaporation of moisture, an oven temperature of 325 °F (162.8 °C) should be used.

- Boned and rolled meat require more cooking time per pound than bone-in cuts because it takes longer for the heat to penetrate through the solid meat. Rolled, tenderized, or scored cuts of meat should be cooked to 145 °F (62.8 °C) with a 3-minute rest time.
- USDA does not recommend cooking meat and poultry at oven temperatures lower than 325 °F (162.8 °C). This can cause food to remain in the “Danger Zone” for too long—temperatures between 40 to 140 °F (4.4 to 60 °C)—allowing bacteria to multiply rapidly.

(For *Turkey and Chicken*, see pages 23-26.)

### Watch Temperatures Closely

Fat content (or a lack of it) affects the cooking times of a variety of meats — so keep a close eye on your roast to avoid overcooking, and use a food thermometer. And remember — regardless of the size of the roast, it still must be cooked to a safe internal temperature.

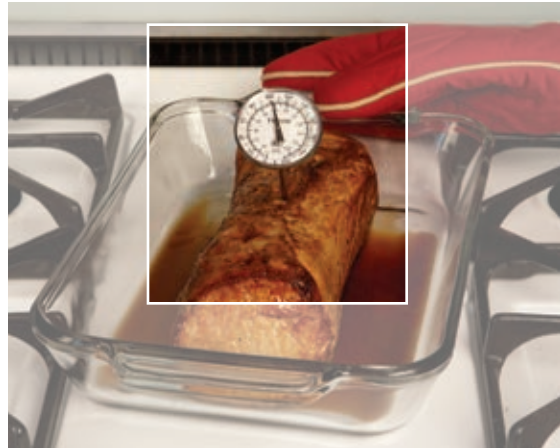



## Roasting Chart

| Meat  | Oven Temperature<br>°F (°C)        | Timing (Approximate)     | Safe Minimum Internal Temperature<br>°F (°C) |
|---|------------------------------------|--------------------------|--|
| <b>BEEF, FRESH</b>                                  |                                    |                          |  |
| Rib roast, bone in<br>4 to 6 pounds                 | 325 °F (163 °C)                    | 23 to 25 minutes per lb. | 145 °F (62.8 °C) with a 3-minute rest time   |
| Rib roast, boneless, rolled<br>4 to 6 pounds        | 325 °F (163 °C)                    | 28 to 33 minutes per lb. | 145 °F (62.8 °C) with a 3-minute rest time   |
| Round or rump roast<br>2 ½ to 4 pounds              | 325 °F (163 °C)                    | 30 to 35 minutes per lb. | 145 °F (62.8 °C) with a 3-minute rest time   |
| Tenderloin, whole<br>4 to 6 pounds                  | 425 °F (218 °C)                    | 45 to 60 minutes per lb. | 145 °F (62.8 °C) with a 3-minute rest time   |
| <b>LAMB, FRESH</b>                                  |                                    |                          |  |
| Leg, bone in<br>5 to 7 pounds<br>7 to 9 pounds      | 325 °F (163 °C)<br>325 °F (163 °C) | 20 to 25 minutes per lb. | 145 °F (62.8 °C) with a 3-minute rest time   |
| Leg, boneless, rolled<br>4 to 7 pounds              | 325 °F (163 °C)                    | 25 to 30 minutes per lb. | 145 °F (62.8 °C) with a 3-minute rest time   |
| <b>VEAL, FRESH</b>                                  |                                    |                          |  |
| Shoulder roast, boneless<br>3 to 5 pounds           | 325 °F (163 °C)                    | 35 to 40 minutes per lb. | 145 °F (62.8 °C) with a 3-minute rest time   |
| Leg rump or round roast,<br>boneless, 3 to 5 pounds | 325 °F (163 °C)                    | 35 to 40 minutes per lb. | 145 °F (62.8 °C) with a 3-minute rest time   |

For reasons of personal preference, consumers may choose to cook the above meats and poultry to higher temperatures.



**CHICKEN, FRESH** (Turkey Cooking Charts can be found on page 26.)

|  |                 |                  |                  |
|--|-----------------|------------------|------------------|
| Whole roasting hen<br>5 to 7 pounds      | 350 °F (177 °C) | 2 to 2 ¼ hours   | 165 °F (73.9 °C) |
| Breast, halves, bone-in<br>6 to 8 ounces | 350 °F (177 °C) | 30 to 40 minutes | 165 °F (73.9 °C) |
| Breast, halves, boneless<br>4 ounces     | 350 °F (177 °C) | 20 to 30 minutes | 165 °F (73.9 °C) |
| Legs or thighs<br>4 to 8 ounces          | 350 °F (177 °C) | 40 to 50 minutes | 165 °F (73.9 °C) |

**PORK, FRESH** (Tip: When cooking to safe temperatures, fresh pork may still be pink inside – but it will be safe.)

|  |                 |                          |  |
|--|-----------------|--------------------------|--|
| Loin roast, bone-in or boneless<br>2 to 5 pounds | 325 °F (163 °C) | 20 to 30 minutes per lb. | 145 °F (62.8 °C) with a 3-minute rest time |
| Crown roast, 4 to 6 pounds                       | 325 °F (163 °C) | 20 to 30 minutes per lb. | 145 °F (62.8 °C) with a 3-minute rest time |
| Tenderloin<br>½ to 1 ½ pounds                    | 425 °F (218 °C) | 20 to 30 minutes total   | 145 °F (62.8 °C) with a 3-minute rest time |

**HAM, SMOKED**

|   |                                    |  |                                  |
|---|------------------------------------|--|----------------------------------|
| Fresh, cook-before-eating,<br>bone-in whole, 10 to 14 pounds<br>half, 5 to 7 pounds | 325 °F (163 °C)<br>325 °F (163 °C) | 18 to 20 minutes per lb.<br>22 to 25 minutes per lb. | 145 °F (60 °C)<br>145 °F (60 °C) |
| Fully cooked, bone-in<br>Whole, 10 to 14 pounds<br>Half, 5 to 7 pounds              | 325 °F (163 °C)<br>325 °F (163 °C) | 15 to 18 minutes per lb.<br>18 to 24 minutes per lb. | 140 °F (60 °C)<br>140 °F (60 °C) |
| Fully cooked, spiral cut, whole or<br>half, 7 to 9 pounds                           | 325 °F (163 °C)                    | 10 to 18 minutes per lb.                             | 140 °F (60 °C)                   |

Soak 4 to 12 hours in refrigerator. Cover with water, then boil 20 to 25 minutes per pound. Drain, glaze, and brown at 400 °F (204 °C) for 15 minutes.

For reasons of personal preference, consumers may choose to cook the above meats and poultry to higher temperatures.



# Turkey

No doubt about it, millions of Americans view holiday time as “turkey time.” Of the millions of turkeys produced every year, 30 percent are served at Thanksgiving and Christmas. But no matter when you are preparing and serving your turkey, gobble up these important facts first!

## Choosing Your Turkey

When selecting your turkey, allow **1 pound of turkey per person** for fresh or frozen;  $1\frac{1}{4}$  pound per person for frozen pre-stuffed.

- **Frozen:** Make sure you have adequate space in your freezer.
- **Fresh:** Purchase it 1 to 2 days before cooking. Refrigerate on a tray or in a pan to catch any juices that may leak.
- **Frozen Pre-stuffed:** Check packaging for the USDA or State mark of inspection, which ensures that it has been processed under controlled conditions. Follow package directions carefully for storage and cooking. **DO NOT THAW** before cooking. Cook from the frozen state.
- **Safety Alert:** Do not buy a **fresh pre-stuffed turkey** because bacteria spread easily from the bird to the stuffing.

## Thawing Your Turkey

For basic food thawing recommendations, see the *Thawing* section on page 16.

In addition, keep these turkey-specific timelines and tips in mind:

- **In the Microwave:** Check the manufacturer’s instructions for the size turkey that will fit into your oven, the minutes per pound, and the power level for thawing. Remove any outside wrapping and place it on a microwave-safe dish to catch any dripping juices. Cook immediately after thawing.
- **For Frozen Turkeys:** Forget to thaw? It’s safe to cook a turkey from the frozen state. Keep in mind that cooking will take **at least 50 percent longer** than with a fully thawed turkey.
- **About refreezing:** Decide not to cook? A turkey that has been safely thawed in the refrigerator can be refrozen safely.
- After thawing, poultry may be left in the refrigerator for up to 2 days before cooking.

**Turkey Thawing Chart: Approximate Timelines**

| Turkey Size     | In the Refrigerator<br>(Approximately 24 hours<br>for every 4 to 5 lbs.) | In Cold Water<br>(Approximately<br>30 minutes per lb.) |
|-----------------|--|--|
| 4 to 12 pounds  | 1 to 3 days  | 2 to 6 hours   |
| 12 to 16 pounds | 3 to 4 days  | 6 to 8 hours   |
| 16 to 20 pounds | 4 to 5 days  | 8 to 10 hours  |
| 20 to 24 pounds | 5 to 6 days  | 10 to 12 hours   |

## Stuffing Your Turkey

- For more even cooking, cook your stuffing outside the bird in a casserole dish. Use a food thermometer to check the internal temperature of the stuffing. The center should reach 165 °F (73.9 °C).
- If you choose to stuff your turkey or other poultry, keep wet and dry ingredients separate and combine just before stuffing.
  - If preparing ahead of time, chill all of the wet ingredients (butter/margarine, cooked celery and onions, broth, etc.).
  - Mix wet and dry ingredients just before filling the turkey cavity. The stuffing should be moist, not dry, since heat destroys bacteria more rapidly in a moist environment. Fill the cavities loosely.
  - **Cook the turkey immediately.** Use a food thermometer to make sure the center of the stuffing reaches 165 °F (73.9 °C).
  - If stuffing does not reach this temperature when the meat itself is done, continue to cook the whole, stuffed bird until the stuffing reaches 165 °F (73.9 °C).

### Got Giblets?

- Remember to remove the giblets from the turkey cavities after thawing. Cook them separately.



## Roasting Your Turkey

- Set your oven temperature no lower than 325 °F (163 °C). Place your turkey or turkey breast on a rack in a shallow roasting pan, and use the **Turkey Roasting Chart** on page 26 as a guide.
- If you're using an oven roasting bag, follow the manufacturer's instructions!
- Cook to a safe minimum internal temperature of 165 °F (73.9 °C) throughout the bird.
- Check the internal temperature in the innermost part of the thigh and wing **and** the thickest part of the breast.
- For reasons of personal preference, you may choose to cook to higher temperatures.
- If your turkey has a "pop-up" temperature indicator, also check the internal temperature of the whole poultry in the innermost part of the thigh and wing and the thickest part of the breast to make sure it has reached at least 165 °F (73.9 °C).
- Let the turkey stand for 20 minutes before carving to allow juices to set. The turkey will carve more easily.

## A Note About Other Cooking Methods

Turkey isn't just about roasting anymore. There are several other ways to prepare the bird. Use the chart on page 26 for at-a-glance guidelines.

## Turkey Roasting Chart: Approximate Times

Fresh or Thawed Turkey • Set oven at 325 °F (163 °C) • Cook to 165 °F (73.9 °C)

| Size of Turkey         | Unstuffed      | Stuffed                |
|------------------------|----------------|------------------------|
| 4 to 6 pounds (breast) | 1½ to 2¼ hours | Not usually applicable |
| 6 to 8 pounds (breast) | 2¼ to 3¼ hours | 2½ to 3½ hours         |
| 8 to 12 pounds         | 2¾ to 3 hours  | 3 to 3½ hours          |
| 12 to 14 pounds        | 3 to 3¾ hours  | 3½ to 4 hours          |
| 14 to 18 pounds        | 3¾ to 4¼ hours | 4 to 4¼ hours          |
| 18 to 20 pounds        | 4¼ to 4½ hours | 4¼ to 4¾ hours         |
| 20 to 24 pounds        | 4½ to 5 hours  | 4¾ to 5¼ hours         |

**Cooking a Frozen Turkey:** The cooking time will take at least 50% longer than recommended for a fully thawed turkey (see above chart).

## Alternate Ways to Cook Turkey

*Note: Always make sure whole turkeys reach a safe minimum internal temperature of 165 °F (73.9 °C) as measured in the innermost part of the thigh and wing and the thickest part of the breast.*

| Method  | Size         | Estimated Cooking Time  | Notes  |
|---|--------------|---|--|
| Electric Roaster Oven                                 | 8 to 24 lbs. | Generally same times as for oven roasting (see above).            | Minimum oven temperature 325 °F (163 °C). Check appliance manual.                        |
| Grilling: Covered Charcoal Grill or Covered Gas Grill | 8 to 16 lbs. | 15 to 18 minutes per pound.<br>DO NOT STUFF.                      | Air in the grill must maintain 225 to 300 °F (107 to 149 °C); use drip pan.              |
| Smoking   | 8 to 12 lbs. | 20 to 30 minutes per pound.<br>DO NOT STUFF.                      | Air in the smoker must maintain 225 to 300 °F (107 to 149 °C); use drip pan with liquid. |
| Deep Fat Frying                                       | 8 to 12 lbs. | 3 to 5 minutes per pound.<br>DO NOT STUFF.                        | Oil must maintain 350 °F. (177 °C). Follow manufacturer's instructions.                  |
| Microwaving   | 8 to 14 lbs. | 9 to 10 minutes per pound on medium (50%) power.<br>DO NOT STUFF. | Use oven cooking bag. Rotate during cooking.   |

*For chicken roasting instructions, see chart on page 23.*

## Chicken

*What's for dinner tonight? There's a good chance it's chicken—now the number one species consumed by Americans.*

### How to Handle Chicken Safely

- Fresh chicken is kept cold during distribution to retail stores to prevent the growth of bacteria and to increase its shelf life.
- At home, immediately place chicken in a refrigerator that maintains a temperature of 40 °F (4.4 °C) or below. Use it within 1 or 2 days, or freeze it at 0 °F (-17.8 °C). If kept frozen continuously, it will be safe indefinitely. Chicken may be frozen in its original packaging or repackaged.

### Rinsing or Soaking Chicken

Washing raw poultry before cooking is not recommended. Bacteria in raw meat and poultry juices can be spread to other foods, utensils, and surfaces. This is called cross-contamination. Rinsing or soaking chicken does not destroy bacteria—only cooking does.

### Marinating

Chicken may be marinated in the refrigerator up to 2 days. Boil used marinade before brushing on cooked chicken. Discard any uncooked leftover marinade.



### Safe Cooking

Cook whole chicken to a safe minimum internal temperature of 165 °F (73.9 °C) as measured using a food thermometer. Check the internal temperature in the innermost part of the thigh and wing and the thickest part of the breast.

In a 350 °F (177 °C) oven, a whole 4-pound chicken will take approximately 1 1/2 hours; a 4-ounce boneless chicken breast, approximately 20 to 30 minutes. For more cooking methods, see page 23 or the chart in “Chicken from Farm to Table” at [www.fsis.usda.gov](http://www.fsis.usda.gov).

### Take-Out Chicken

When purchasing fully cooked rotisserie or fast food chicken, be sure it is hot at the time of purchase. Use it within 2 hours or cut it into several pieces and refrigerate in shallow, covered containers. Eat within 3 to 4 days or freeze for longer storage.

### *Prevent Cross-Contamination!*

Always wash hands with soap and warm water before and after contact with raw poultry or its juices. Wash all utensils, the sink, and countertops with hot, soapy water.

---

## Eggs and Egg-Rich Food

*Eggs can be part of a healthy diet. However, they are perishable just like raw meat, poultry, and seafood — and just like these foods, they must be properly refrigerated and cooked for safety. So get cracking!*

### Storing:

- **Refrigerate Eggs.** Take eggs straight home and store them in their original carton in the refrigerator. Follow the 2-Hour Rule: Never allow eggs to be unrefrigerated for more than 2 hours.
  - Place them on a refrigerator shelf, not in the door, where they'd be exposed to warm air every time the door is opened.
  - If any eggs cracked on the way home from the store, break them into a clean container, cover tightly, refrigerate, and use within 2 days.
- **Keep Easter/Decorated Eggs Refrigerated, Too.** Even with egg hunts, the 2-Hour Rule still applies — make sure your “hide-and-seek” activities occur within 2 hours (1 hour when the temperature is above 90 °F/32.2 °C), and then re-refrigerate the eggs.
- **Freeze Beaten Eggs for Longer Storage.** Eggs should not be frozen in their shells. To freeze whole eggs, beat yolks and whites together. Egg whites can also be frozen by themselves.

### Cooking:

- **Cook Thoroughly.** To ensure safety, eggs must be cooked until **yolks are firm**. Scrambled eggs should **not** be runny.
  - Raw eggs and other ingredients, combined according to recipe directions, should be cooked immediately or refrigerated and cooked within 24 hours.
  - Casseroles and other dishes containing eggs should be cooked to 160 °F (71.1 °C) as measured with a food thermometer.
  - Serve cooked eggs and dishes containing eggs immediately after cooking, or place in shallow containers for quick cooling and refrigerate at once for later use. Use within 3 to 4 days.
  - If eggs crack during hard cooking, they are safe.
- **Never Eat Raw Eggs.** This includes “health-food” milk shakes with raw eggs, Caesar salad, Hollandaise sauce, homemade mayonnaise, ice cream, or eggnog, and any other food made from recipes in which the raw egg ingredients are not cooked.
- All egg products, such as liquid eggs, are pasteurized and may be used in products that will not be cooked. However, egg products are best used in a cooked product, especially if serving high-risk persons (pregnant women, newborns, young children, older adults, and people with weakened immune systems).

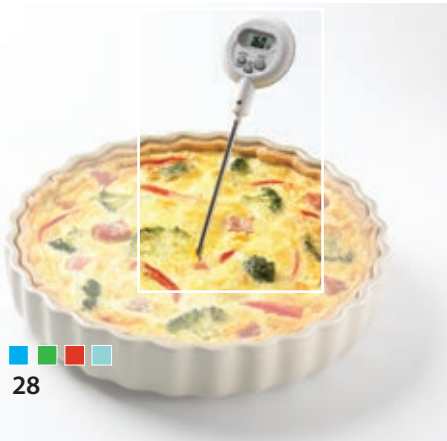

## Egg Storage Chart

| Product                                    | Refrigerator                                     | Freezer  |
|--|--|--|
| Raw eggs in shell                          | 3 to 5 weeks                                     | Do not freeze. Instead, beat yolks and whites together; then freeze. |
| Raw egg whites                             | 2 to 4 days                                      | 12 months  |
| Raw egg yolks                              | 2 to 4 days                                      | Yolks do not freeze well.  |
| Raw egg accidentally frozen in shell       | Use immediately after thawing.                   | Keep frozen; then thaw in the refrigerator.                          |
| Hard-cooked eggs                           | 1 week   | Do not freeze.   |
| Egg substitutes, liquid<br><i>Unopened</i> | 10 days  | 12 months  |
| <i>Opened</i>                              | 3 days   | Do not freeze.   |
| Egg substitutes, frozen<br><i>Unopened</i> | After thawing, 7 days, or refer to "Use-By" date | 12 months  |
| <i>Opened</i>                              | After thawing, 3 days, or refer to "Use-By" date | Do not freeze.   |
| Casseroles with eggs                       | 3 to 4 days                                      | After baking, 2 to 3 months.   |
| Eggnog<br><i>Commercial</i>                | 3 to 5 days or "Use-By" date                     | 6 months   |
| <i>Homemade</i>                            | 2 to 4 days                                      | Do not freeze.   |
| Pies<br>Pumpkin or pecan                   | 3 to 4 days                                      | After baking, 1 to 2 months.   |
| Custard and chiffon                        | 3 to 4 days                                      | Do not freeze.   |
| Quiche with filling                        | 3 to 4 days                                      | After baking, 1 to 2 months.   |

### Egg Recipes: Playing it Safe

- ✓ **Egg mixtures** are safe if they reach **160 °F (71.1 °C)**.
- ✓ **Homemade ice cream and eggnog** are safe if made from a cooked **egg-milk mixture**. Heat it gently and use a food thermometer to ensure that it reaches **160 °F (71.1 °C)**.
- ✓ **Dry meringue shells, divinity candy, and 7-minute frosting** are safe — these are made by combining hot sugar syrup with beaten egg whites. However, avoid icing recipes using uncooked eggs or egg whites.
- ✓ **Meringue-topped pies** should be safe if baked at **350 °F (177 °C)** for about 15 minutes. But avoid chiffon pies and fruit whips made with raw, beaten egg whites — instead, substitute pasteurized dried egg whites, whipped cream, or a whipped topping.
- ✓ **Adapting Recipes:** If your recipe calls for uncooked eggs, make it safe by heating the eggs in one of the recipe's other liquid ingredients over low heat, stirring constantly, until the mixture reaches **160 °F (71.1 °C)**. Then, combine it with the other ingredients and complete the recipe.
- ✓ **Use a Food Thermometer:** To determine safety in egg dishes, such as quiche and casseroles, the center of the mixture should reach 160 °F (71.1 °C) when measured with a food thermometer.

---

## Hot Dogs and Luncheon Meat

*Hot dogs and luncheon meat are processed to last longer than other meat, but they can still spoil or harbor foodborne bacteria. Here are tips for keeping them safe.*

### Storing:

- Keep **unopened hot dogs and prepackaged cold cuts** in the refrigerator in their original vacuum-sealed package for up to 2 weeks. For quality reasons, use hot dogs **no later than 1 week** after the “Sell-By” date.
  - Once opened, rewrap well and use within **3 to 5 days** or freeze.
- **You can freeze** hot dogs and luncheon meat, but there may be flavor and texture loss after 1 to 2 months.

### *A Note for Those “At Risk”*

Those at increased risk of foodborne illness should **reheat hot dogs and luncheon meat** until steaming hot before eating, due to the threat of listeriosis.

---

## Leftovers

*Leftovers are a staple in the kitchen. But they also need special care to ensure safe storage and reheating. These guidelines will help ensure their safety the “second time around.”*

### Storing:

- **Hot food** can be placed directly in the refrigerator, or it can be rapidly chilled in an ice or cold water bath before refrigerating. Cover food to retain moisture and prevent it from picking up odors from other food in the fridge, and use shallow containers for rapid cooling.
- Divide a **large pot of food**, like soup or stew, into shallow containers before refrigerating.
- A **large cut of cooked meat or whole poultry** should be divided into smaller pieces and wrapped separately or placed in covered, shallow containers before refrigerating.
- Discard perishable food if it has been left

at room temperature for more than 2 hours (1 hour if it's above 90 °F/32.2 °C). This includes leftovers that were **mistakenly left out** overnight.

### Reheating:

- Heat leftovers to **165 °F (73.9 °C)** — use a food thermometer to check!
- Bring gravies and sauces to a **rolling boil** before serving.
- **Cover leftovers** to reheat. This retains moisture and ensures that food will heat all the way through.
- **In the microwave**, cover the dish of food with a lid or vented plastic wrap. For even heating, rotate the dish during microwaving and stir if possible. Beware of cold spots; use a food thermometer to check the temperature in several places.

### *“Take-Home” Leftover Alert:*

Doggie Bags are leftovers, too! Follow the same rules for storing and reheating.





# specific preparation and cooking methods

*"Making dinner" can go far beyond simply putting a roast in the oven. These basic guidelines will keep your food safe as you use a variety of cooking and preparation techniques.*

## Marinating

Marinades can enhance the flavor of meat, poultry, or seafood. Follow these tips for marinating safely.

- **Marinate in the Refrigerator.**

Marinate at refrigeration temperatures —40 °F (4.4 °C), to keep bacteria from growing. Meat and poultry can be marinated for several hours or days to tenderize or add flavor.

- **Don't "Cross-Contaminate."** Sauce used to marinate raw meat, poultry, or seafood should *never* be used on cooked foods unless it is boiled just before using.

- Sauce used to marinate raw meat contains raw juices that can contain dangerous bacteria.

- If some of the marinade is to be used as a sauce on the cooked food, reserve a portion of the marinade before putting raw meat or poultry in it.

- **Don't Use Metal.** Marinate in glass or plastic. The process may take several hours, so you need a tray or bowl that won't be affected by acid.

## Microwave Cooking

On a hungry night after a long day, a microwave oven can be a cook's best friend. While saving time in food preparation, it's still critical to make sure food reaches a safe minimum internal temperature throughout.

- **Prep and Cover:** Arrange food items evenly in a covered dish and add some liquid if needed. Cover the dish with a lid or plastic wrap; loosen or vent the lid or wrap to let steam escape. The moist heat that is created will help destroy harmful bacteria and ensure uniform cooking. Cooking bags also provide safe, even cooking.

- **Avoid Cold Spots:** While microwaving is quick, it doesn't always cook food evenly. Stir or rotate food midway through the microwaving time to eliminate cold spots and for more even cooking.

- **Defrost in the Microwave *Only* if Cooking Immediately.** Cover foods with a lid or a microwave-safe plastic wrap to hold in moisture and provide safe, even heating.

- **Use Partial Cooking With Care:** Partial cooking may be done in the microwave *only* if the food is to finish cooking immediately, either on the stovetop, grill, or in a conventional oven.



more →



- **Observe Rest Times:** These are stated in recipes, and they are important for ensuring that the cooking process is completed.

- Rest times allow internal cooking to continue after the food is cooked in the microwave. They are necessary in order to kill possible foodborne bacteria that may be present in meat and poultry.
- Try covering food with foil during standing time to retain heat (but don't use foil in the microwave!).

- **Use a food thermometer.** Check temperature in several places to ensure a safe minimum internal temperature has been reached. (For safe temperature guidelines, see the *Safe Minimum Internal Temperature Chart* on page 19.)

- **No, You Can't "Can"!** Do not use your microwave for home canning. As liquid inside the sealed glass jar heats and expands, pressure can build up, causing the jar to explode.

If you have any questions about proper microwave use, check the **manufacturer's instructions**.



When preparing convenience foods, follow our **Cook It Safe!** steps to food safety:

1. Read and Follow Package Cooking Instructions.
2. Know when to use a Microwave or Conventional Oven.
3. Know Your Microwave Wattage before Microwaving.
4. Always Use a Food Thermometer to ensure a Safe Minimum Internal Temperature.

For more information on microwave food safety, visit the Partnership for Food Safety website at [www.fightbac.org/cookitsafe](http://www.fightbac.org/cookitsafe).

## Grilling and Barbecuing

Summer is peak time for grilling even though many cooks use their grills year round, whatever the weather. Whenever or wherever you're grilling, keep these hot tips in mind.

(Traveling to the cookout? Don't miss *Transporting Food* beginning on page 38.)

### Grilling Guidelines:

- **Remember your food thermometer!** Meat and poultry cooked on a grill can brown quickly on the *outside* — use a food thermometer to be sure the food has reached a safe minimum *internal* temperature.  
(See *Safe Minimum Internal Temperature Chart* on page 19, and *Food Thermometers and Temperature Indicators* on page 18.)
- **Consider partial precooking.** Partial cooking in the microwave, oven, or



on the stove is a good way to reduce grilling time. Just make sure that the food goes **immediately** onto the preheated grill to complete cooking. **Never** partially grill meat or poultry and finish cooking it later.

- **Use a clean platter for cooked food.**

Don't put the grilled food on the same platter that held raw meat or poultry because any harmful bacteria present in the raw juices could contaminate safely cooked food.

(See also: *Cross-Contamination* on page 8, *Marinating* on page 31, and *Serving Food Safely: General Guidelines* on page 35.)

## Smoking

Smoking is cooking food *indirectly* in the presence of a fire. Smoking is done much more slowly than grilling, so *less tender meats* benefit from this method and result in a natural “smoke” flavor permeating the meat. As with any method of cooking, follow the basic steps for safety before smoking:

- **Preparation:** Defrost meat entirely—and safely—before smoking. Marinate meat in the refrigerator.

(See *Thawing* on page 16 and *Marinating* on page 31.)

- **Partial Cooking:** If you decide to cook food partially in a microwave oven or on the stove to reduce smoking time — make sure that the food goes *immediately* from the microwave or stove to the hot smoker.
- **Two Thermometers:** To smoke meat and poultry safely, you'll need **two types of thermometers**. Cooking time depends on many factors, and since it can take anywhere from 4 to 8 hours to smoke meat or poultry, the *only* way to monitor the safety and doneness is to use the two thermometers.

— **Smoker Thermometer:** These are often built in. The smoker thermometer enables you to ensure that the **temperature in the smoker** stays between 225 and 300 °F (107 and 149 °C) for safety.

— **Food Thermometer:** Once **food** is in the smoker, cook until it reaches a safe internal minimum temperature as determined with a food thermometer.

(See *Safe Minimum Internal Temperature Chart* on page 19, and *Food Thermometers and Temperature Indicators* on page 18.)

- **Prompt chilling:** If you aren't taking your smoked food straight to the dinner table, refrigerate meat and poultry within 2 hours after cooking is complete (1 hour when the temperature is above 90 °F/32.2 °C). Cut the meat or poultry into smaller

more →





portions or slices, place it in shallow containers, cover, and refrigerate. Use it within 4 days, or freeze for later use.

## Slow Cooking

In today's multitasking world, there's nothing like having dinner cooked **for** you while you go about your day.

That's the beauty of a slow cooker. As you take advantage of this time-saving wonder, here are tips for keeping your "crock o' dinner" safe.

- **How Slow Cookers Work:** As the name implies, the countertop "slow cooker" cooks foods slowly and at a low temperature—generally between 170 and 280 °F (76.7 to 138 °C).
  - The direct heat from the pot, lengthy cooking time, and steam created within the tightly covered container work in combination to destroy bacteria and make the slow cooker a **safe process** for cooking foods.
  - While food is cooking and once it's done, food will stay safe as long as the cooker is operating.
- **Preparation:** Since the slow cooker may take several hours to reach a safe bacteria-killing temperature, keep perishable ingredients refrigerated right up until preparation time. This keeps bacteria from getting a "head start."

- Always defrost meat or poultry **before** putting it into a slow cooker.
- If you cut up meat and vegetables in advance, store them separately in the refrigerator.
- Keep the lid in place, removing only to stir the food or check for doneness.

- **Choose Appropriate Recipes:**

- Choose to make foods with a high-moisture content such as chili, soup, stew, or spaghetti sauce.
- Large cuts of meat and poultry may be cooked safely in a slow cooker.
- Add the meat and desired amount of liquid suggested in the recipe, such as broth, water, or barbecue sauce. Keep the lid in place, removing only to stir the food or check for doneness.
- If using a commercially frozen slow-cooker meal, prepare according to manufacturer's instructions.

- **Slow-Cooker Leftovers:** Store leftovers in shallow, covered containers and refrigerate within 2 hours after cooking is finished. **Do not** reheat leftovers in a slow cooker. Heated, cooked food may be transferred to a preheated slow cooker to keep hot for serving.

- **If the Power Goes Out:**

- If you are not at home and the power goes out, throw away the food even if it looks done.
- If you **are** at home, finish cooking the ingredients immediately on a gas stove, on the outdoor grill, or at a house that has power. Food cooked completely before the power went out should remain safe up to 2 hours in the cooker without power.

# serving food safely

*“Dinner is served!” More than ever, this happens in a wide variety of places, both indoors and out. But no matter where your meal is taking place . . . safety must still be the first item on the menu.*

## **General Guidelines: Whatever or Wherever You’re Serving!**

- **Keep Hot Food Hot & Cold Food Cold.**

Whether you are in your kitchen or enjoying the great outdoors, there are some food safety principles that remain constant. The first is “Keep hot food hot and cold food cold” to keep foods out of the “Danger Zone.”

(See *Focus on: The “Danger Zone”* on page 9.)

- **Keep Everything Clean.** It’s a fact that bacteria from raw meat and poultry products can easily spread to other foods by hands, utensils, or by juices dripping from packages.

- When **transporting raw meat or poultry**, double-wrap or place the packages in plastic bags to prevent juices from the raw product from dripping on other foods.

- Always **wash your hands** before and after handling food, and **don’t use the same platter and utensils** for raw and cooked meat and poultry unless you wash them first.

- **Soap and water are essential** to cleanliness, so if you are going somewhere that will not have running water, bring it with you or have disposable wipes on hand.

(See *Cross-Contamination* on page 8.)

- **Remember the 2-Hour Rule:**

Perishable food should never be left in the “Danger Zone”—**between 40 and 140 °F (4.4 and 60 °C)**—for more than 2 hours. This includes both hot food and cold food. If it’s been more than 2 hours (or 1 hour in temperatures above 90 °F/32.2 °C), discard the food.

- **Be Cool:** If you are traveling with cold food, bring a cooler with a cold source. It is difficult to keep food hot without a heat source when traveling, so it’s best to cook food before leaving home and refrigerate and transport cold.

(See *Transporting Food* on page 38.)



## Buffets . . . Cooking for Groups

Food sitting out for extended periods of time is a recipe for potential disaster. In addition to the basics for temperature and cleanliness, follow these guidelines when cooking for and/or serving groups:

- **Safe Advance Prep:** If you're getting ready ahead of time, be sure to cook food thoroughly to safe minimum internal temperatures. (See *Safe Minimum Internal Temperature Chart* on page 19.) Divide cooked food into shallow containers to store in the refrigerator or freezer until serving. This encourages rapid, even cooling.
  - Reheat hot food to 165 °F (73.9 °C) and maintain at a safe temperature of 140 °F (60 °C) or above.
  - Don't risk cross-contamination: place cold food on clean platters. Arrange on several small platters rather than on one large platter, and keep all platters cold in the refrigerator until serving time.

- **Remember the "Temperature Rules":** Keep **hot food hot** (140 °F/60 °C or above) with chafing dishes, slow cookers, and warming trays. **Cold food** should be held at 40 °F (4.44 °C) or below, so keep food cold by nesting dishes in beds of ice. Or use a series of small serving trays and replace them often.
  - **Replace** empty platters—don't **refill** them. Discard food that has been sitting out and may have been handled by many people.
- **2-Hour Rule:** As always, perishable food should not be left out for more than 2 hours at room temperature—1 hour when the temperature is above 90 °F (32.2 °C). Be sure to keep this in mind as the party rocks on—and when in doubt, throw it out.  
(Also see *Transporting Food* beginning on page 38.)

### Remember the Temperature Rules

Keep **hot food hot**  
at 140 °F (60 °C) or above  
&  
Keep **cold food cold**  
at 40 °F (4.44 °C) or below



## Take-Out and Delivered Food

With take-out or delivered food, the cook gets to take a shortcut with meal preparation, but not with food safety. Basic guidelines still apply.

### Hot Take-Out or Delivered Food

- **Hot Food Hot . . .** Hot food must be kept out of the “Danger Zone” (see page 9), and that means just keeping it “warm” is not enough.
  - If you aren’t going to eat it right away, **use a food thermometer** to monitor the internal temperature of the food, and don’t let it drop below 140 °F (60 °C). A preheated oven, chafing dishes, preheated warming trays, or slow cookers may be used to keep food hot.
  - If you plan to eat at a later time, take-out or delivered food should be **divided into smaller portions or pieces**, placed in shallow containers, and refrigerated. Reheat to 165 °F (73.9 °C) as you would any leftover. (See *Safe Minimum Internal Temperature Chart* on page 19.)

## Cold/Refrigerated Take-Out or Delivered Food

- . . . **And Cold Food Cold.** Cold food should be kept at 40 °F (4.44 °C) or below. Refrigerate perishable food as soon as possible, always within 2 hours after purchase or delivery.
    - If the food is in air temperatures above 90 °F (32.2 °C), refrigerate within 1 hour.
    - When take-out or delivered food is purchased cold for an outdoor event—like a picnic, sporting event, or outdoor buffet—a cooler with ice is a practical alternative to a refrigerator. The cooler should be packed with plenty of ice or frozen gel packs. Keep the cooler in the shade when possible.
- (See next page: *Transporting Food*.)



# ■ ■ ■ transporting food: coolers, picnics, and bag lunches

*When it comes to food, you can take it with you, but you need to do it safely, too. Whether you're tailgating, picnicking, or just packing your lunch, start with a clean cooler or lunch pack and begin by preparing food using standard "clean" practices. (See *Food Preparation* beginning on page 15.) In addition, follow these special guidelines to keep your packed food safe wherever your travels take you.*

## Bag Lunches

Bag lunches aren't just for school kids. Wherever you're going, pack only the amount of perishable food that can be eaten at lunch to avoid worrying about the storage or safety of leftovers.

### Cold Food:

- Prepare cooked food, such as turkey, ham, chicken, and vegetable or pasta salad, ahead of time to allow for thorough chilling in the refrigerator. Try preparing it the night before.
- Freezing sandwiches helps them stay cold. For best quality, don't freeze sandwiches containing mayonnaise, lettuce, or tomatoes; add these ingredients later.
- Keep cooked food refrigerated until time to leave home. To keep lunches cold away from home, include at least two cold sources: two frozen gel packs (not smaller than 5x3-inches each) or a frozen gel pack with a frozen juice box or frozen bottle of water. Place them on top and bottom of the perishable food items to keep them cold. If a refrigerator is available, store perishable items there upon arrival. If you place your insulated bag in the refrigerator, leave the lid or bag open so that cold air can keep the food cold.

### Hot Food:

- Use an insulated container to keep food like soup, chili, and stew hot. Fill the container with boiling water, let it stand for a few minutes, empty the water out, and then put in piping hot food. Keep the insulated container closed until lunchtime to keep the food hot. For safety, it needs to stay at 140 °F (60 °C) or above.
- When using the microwave oven to reheat lunches, cover food to hold in moisture and promote safe, even heating. Reheat leftovers to at least 165 °F (73.9 °C), making sure to use a food thermometer to be sure a safe temperature has been reached before consuming the food. Cook frozen convenience meals according to package instructions.





## Coolers

The cooler is the key to keeping cold food out of the “Danger Zone.” Use an insulated cooler with sufficient ice or ice packs to keep the food at 40 °F (4.44 °C) or below.

### Packing:

- As you prepare, **divide large amounts of food** into shallow containers for fast chilling and easier use. Keep cooked food refrigerated until it’s time to leave home.
- **Pack food right from the refrigerator** into the cooler immediately before leaving home.
  - For your cold source: use **frozen gel packs or ice**. A block of ice keeps longer than ice cubes. Or, in advance, freeze clean, empty milk cartons filled with water to make **blocks of ice**. Add the ice first, then the food.
- Pack smart! **Pack usable quantities in reverse order:**
  - The *first* foods packed should be the *last* foods to be used. (There is one exception: **Pack raw meat or poultry below ready-to-eat foods** to prevent raw meat or poultry juices from dripping on the other foods.)
  - Take foods in the smallest quantity needed (e.g., a small jar of mayonnaise).
- Consider **packing drinks in a separate cooler** so the food cooler is not opened frequently.

- It is important to pack an **appliance thermometer** in your cooler. Since the food in the cooler should be kept at 40 °F (4.44 °C) or below, you need to be able to monitor it.
- Before you leave home, find out if there’s a **source of clean water** at your destination. If not, bring water for preparation and cleaning. Or, pack clean cloths and moist towelettes for cleaning surfaces and hands.

### Placement:

- At your destination, keep the cooler **in the shade**, and try to **insulate it** with a blanket, tarp, or poncho. Keep the lid closed and avoid repeated openings. Replenish the ice if it melts.
- Remember that the rule for keeping food safe changes during warmer weather. While food can be kept out of the cooler for 2 hours at normal temperatures, if the weather is **above 90 °F (32.2 °C) outside**, food should be returned to a cooler or refrigerated after only 1 hour.

(See *Focus On: The Danger Zone*, page 9.)

### Party’s Over?

- Discard all **used food packaging** and bags — they could contaminate other food and cause foodborne illness, so don’t reuse them.
  - Discard all perishable foods if there is no longer ice in the cooler, or if the **gel packs** are no longer frozen.
- (See also: *Serving Food Safely*, page 35, and *Grilling and Barbecuing*, page 32.)

# food safety for food-by-mail

*Whether you're a giver or a receiver, food sent by mail is more popular than ever. But food safety still matters — especially with perishable foods. With a little groundwork, you'll be assured that the contents of the package on the doorstep are safe to eat.*

## Mail-Order Food:

Before ordering, confirm that the company sends perishable items (like meat or poultry) cold or frozen and packed with a cold source. It should be packed in foam or heavy corrugated cardboard and should be delivered as quickly as possible — ideally, **overnight**.

Also, take these precautions to ensure safe shipping:

- **Proper Labeling:** Confirm that perishable items and the outer package will be labeled "Keep Refrigerated."
- **Alert the Recipient:** Let him/her know if the company has promised a delivery date. Or, alert the recipient that "the gift is in the mail" so someone can be there to receive it. Don't have perishable items delivered to an office unless you know it will arrive on a workday and that there is refrigerator space available for keeping it cold.
- **All Perishables Need Refrigeration:** Even if a product is smoked, cured, and/or fully cooked, it still is a perishable product and must be kept cold.

## "MINIATURE DEEP-FREEZE" PACKAGING

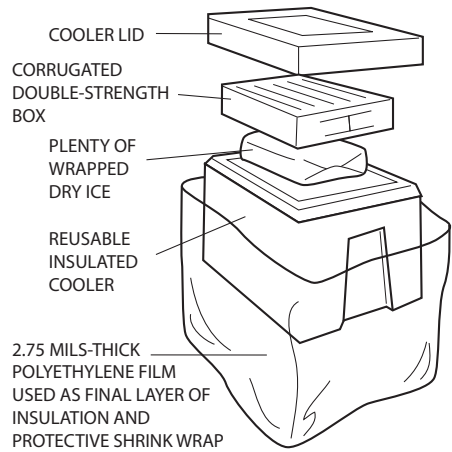

- **When You're the Recipient:** When *you* receive a food item marked "Keep Refrigerated," open it immediately and check its temperature. The food should arrive frozen or partially frozen with ice crystals still visible.  
**Temperature Caution:** Whoever the recipient is, if perishable food arrives warm, notify the company. **Do not consume the food. If you suspect it may not have been properly chilled, don't even taste it.**

## Mailing Homemade Foods

For sending food safely, check out the packing and shipping tips in the fact sheet "**Mail Order Food Safety**" at [www.fsis.usda.gov](http://www.fsis.usda.gov).

# food safety in an emergency

*Keeping the food supply safe is important at all times, but sometimes, it is a greater challenge than others. These situations include power outages, natural disasters, and other emergencies. So be prepared and keep your food safe.*

## Power Outages

Sometimes the power goes out.

### **Be prepared!**

- **Keep an appliance thermometer** in both the refrigerator and freezer. Make sure the refrigerator temperature is at 40 °F (4.44 °C) or below and the freezer is at 0 °F (-17.8 °C) or below.
- **Keep the freezer full.** Fill empty spaces with frozen plastic jugs of water, bags of ice, or gel packs.
- **Keep the refrigerator and freezer doors closed** to keep cold air *inside*.
- The refrigerator will keep food safe for up to **4 hours**. If the power is off longer, you can transfer food to a cooler and fill with ice or frozen gel packs. Make sure there is enough ice to keep food in the cooler at 40 °F or below. Add more ice to the cooler as it begins to melt.
  - If your freezer is not full, group packages so they form an “igloo” to protect each other.
  - For longer power outages, add **dry ice** or **cubed or block ice**.
  - During a snowstorm, do not place perishable food out in the snow. Outside temperatures can vary and food can be exposed to unsanitary conditions and animals. The sun’s rays can thaw frozen food. Instead, make ice in containers left outside to freeze. Then put the “homemade ice” in your refrigerator, freezer, or coolers.

— In general, refrigerated items should be safe **up to 4 hours**.

— Discard any perishable food that has been above 40 °F (4.44 °C) for 2 hours or more. (See **Focus on: The Danger Zone** on page 9.) Also, discard any food that has an unusual odor, color, or texture, or feels warm to the touch. **Never** taste a food to determine its safety!

- **With frozen food: check for ice crystals!** The food in your freezer that partially or completely thaws before power is restored may be safely refrozen if it still contains ice crystals or is 40 °F (4.44 °C) or below.
  - A full freezer will stay at safe temperatures about 2 days; a half-full freezer about 1 day.
  - The freezing compartment in a refrigerator will not keep foods frozen as long.
  - When the power comes back on, you will have to evaluate each item separately. **When in doubt, throw it out.**

## Floods

- Do not eat any food that may have come into contact with **flood water**.
- Discard any food that is not in a **waterproof container** if there is any chance that it has come into contact with flood water. Food containers that are not waterproof include those with

*more →*



screw-caps, snap lids, pull tops, and crimped caps. Also discard cardboard juice/milk/baby formula boxes and home-canned foods if they have come in contact with flood water, because they cannot be effectively sanitized.

- Inspect canned food and discard any food in **damaged cans**. Can damage is shown by swelling, leakage, punctures, holes, fractures, extensive deep rusting, or crushing/denting severe enough to prevent normal stacking or opening with a manual, wheel-type can opener.
- **Undamaged, commercially prepared foods** in all-metal cans and retort pouches (e.g., flexible, shelf-stable juice or seafood pouches) can be saved if the can is properly cleaned and treated.
- **For instructions** on how to salvage all-metal cans and kitchen items, read **“A Consumer’s Guide to Food Safety: Severe Storms and Hurricanes”** at [www.fsis.usda.gov](http://www.fsis.usda.gov).

## Fires

The general rule of thumb is to **discard food that has been near a fire or exposed to smoke fumes**.

- **Food in cans or jars** may appear to be okay, but heat from a fire can activate food spoilage bacteria. If the heat is extreme, the cans or jars themselves

can split or rupture, leaving the food unsafe.

- **Toxic fumes** released from burning materials can get inside food. Discard any raw food or food in permeable packaging — cardboard, plastic wrap, screw-topped jars, bottles, etc. — stored outside the refrigerator.
- Food stored in **refrigerators or freezers** can also become contaminated by fumes. The refrigerator seal isn’t airtight and fumes can get inside.
- **Chemicals used to fight the fire** contain toxic materials and can contaminate food and cookware.
  - **Food** that is exposed to chemicals should be thrown away because the chemicals **cannot** be washed off the food. This includes food stored at room temperature and food stored in permeable containers, like cardboard and screw-topped jars and bottles.
  - **Cookware** exposed to fire-fighting chemicals **can** be decontaminated. Wash it in soap and hot water, then submerge it for 15 minutes in a solution of 1 tablespoon of unscented, liquid chlorine bleach in 1 gallon of water.



*A Post-flood “Sanitation Station”*

# food product recalls

When meat and poultry products are recalled, USDA's Food Safety and Inspection Service notifies the public through a press release. The recall is posted on the FSIS Recall Website: [www.fsis.usda.gov/fsis\\_recalls](http://www.fsis.usda.gov/fsis_recalls).

## Recalls

These recall announcements include:

- Description of the food
- Identifying codes, including the plant number (found in the USDA Inspection Mark on the label)
- Reason for the recall
- Name of the producer
- Distribution information
- Health risk
- Contacts at FSIS and the company

## Recall Rules of Thumb:

- If you discover that you have a recalled product in your home, **do not consume it**. Instead, return it to the place of purchase or discard.
- If you become ill from a recalled product, contact a physician.

For more information, read the fact sheet **"How to Find the USDA Establishment (EST) Number on Food Packaging"** at [www.fsis.usda.gov](http://www.fsis.usda.gov).

## Still Have Questions?

FSIS' *Kitchen Companion* has covered a lot of information on how to keep your family safe at home. But if you find yourself with further questions, FSIS offers round-the-clock food safety answers online.

Meet **"Ask Karen"** — FSIS' "virtual rep." She represents another way FSIS reaches out to consumers in support of its public health mission to assure the safety and security of America's food supply.

### About "Ask Karen":

- She provides food safety information through an extensive database that includes **answers to more than 3,000 questions in English and Spanish**.
- She can provide **detailed information** on:
  - Safe storage, preparation, and handling of meat, poultry, and egg products.
  - Prevention of foodborne illness and disease.

"Ask Karen" is available **24 hours a day, 7 days a week**. FSIS invites you to "Ask Karen" at [www.askkaren.gov](http://www.askkaren.gov) and [www.preguntaleakaren.gov](http://www.preguntaleakaren.gov). Access food safety answers anytime from your mobile device at [m.askkaren.gov](http://m.askkaren.gov).

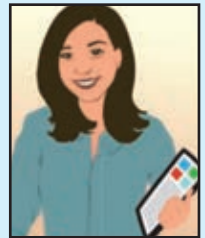



# food safety contacts

## Food Safety Contacts

### USDA Meat and Poultry Hotline:

1-888-MPHOTLINE (1-888-674-6854)

E-mail: [mph hotline.fsis@usda.gov](mailto:mph hotline.fsis@usda.gov)

- Monday – Friday, 10 a.m. to 4 p.m. ET, year round
- Live Chat in English and Spanish
- Recorded food safety messages available 24 hours a day

### USDA Food Safety and Inspection Service Websites:

- “www.Ask Karen,” FSIS’s Web-based automated response system — available 24/7 at [www.askkaren.gov](http://www.askkaren.gov)
- [m.AskKaren.gov](http://m.AskKaren.gov) — scan QR code into your Android or iPhone
- [www.fsis.usda.gov](http://www.fsis.usda.gov) — online 24 hours, 7 days a week

### U.S. Government Food Safety Website:

- [www.foodsafety.gov](http://www.foodsafety.gov)

### ¡Hablamos Español!

[www.PregunteleaKaren.gov](http://www.PregunteleaKaren.gov)

Hay disponible información en español sobre Inocuidad Alimentaria de ambas maneras, electrónicamente y por teléfono.

### Llame al teléfono:

1-888-674-6854

### Visite la página principal electrónica:

[www.fsis.usda.gov/en\\_espanol/index.asp](http://www.fsis.usda.gov/en_espanol/index.asp)

## *For Help With . . .*

**Meat, Poultry, or Processed Egg Products:** 1-888-MPHOTLINE (1-888-674-6854)

**Non-Meat Food Products (Cereals, Fish, Produce, Fruit Juice, Pastas, Cheeses, etc.):**

[www.fda.gov/food](http://www.fda.gov/food) or 1-888-SAFEFOOD (1-888-723-3366)

**Restaurant Food Problems:** Call the Health Department in your city, county, or state.

Visit [www.foodsafety.gov/about/state/index.html](http://www.foodsafety.gov/about/state/index.html) to locate your health department.

**a**

antibiotics, 10  
"Ask Karen" (automated response system), 43, 44, back cover  
"At Risk" groups, 2, 5, 10, 28, 30

---

**b**

bacon, 13  
bacteria, 4, 6, 7, 19, 25  
bag lunches, 38  
barbecuing, 32  
beef, 13, 19, 22  
bleach, 15, 42  
Botulism, 6  
buffets, 5, 36

---

**c**

*Campylobacter jejuni*, 6  
canned food, 14, 42  
casseroles, 28, 29  
Centers for Disease Control and Prevention, 4  
chicken, 13, 19, 23, 27  
chilling, 33, 38  
cleaning, 15, 17, 39  
*Clostridium botulinum*, 6, 14  
*Clostridium perfringens*, 5, 6  
cooking bags (roasting bags), 25, 26,  
cooking temperatures, 21, 22, 26, 27, 29  
cooking times, 22, 23, 27  
coolers, 9, 35, 37, 39  
cross-contamination, 8, 11, 15, 27, 31,  
35, 36  
cutting boards, 15

---

**d**

"Danger Zone", 9, 19, 21, 35, 37, 41  
dates/dating, 8, 10, 11, 20  
deep fat frying, 26  
defrosting, 12, 16, 24

---

**e**

*E. coli* O157:H7 (*Escherichia coli* O157:H7), 5, 6  
egg substitutes, 29  
eggnog, 28, 29  
eggs, 8, 11, 19, 28, 29  
EST, 10

---

**f**

fires, 42  
floods, 41  
Food and Drug Administration (FDA), 44  
food poisoning (see foodborne illness)  
Food Safety and Inspection Service (FSIS), 2  
foodborne illness, 4, 5, 6, 7, 17  
freezer burn, 12  
freezers, 12, 13, 16, 20, 29, 41, 42  
freezing, 11-13, 20, 26-28, 29, 30, 38, 39  
frozen food, 11-13, 16  
fruits, 8, 11, 16, 44

---

**g**

giblets, 25  
grilling, 32  
ground beef (color), 20  
ground meat & poultry (beef, turkey, veal, pork, lamb), 13, 17, 19, 20

---

**h**

ham, 20, 23  
hamburger, 13, 18, 20  
handwashing, 15, 35  
holding temperatures, 19, 36  
hormones, 10  
hot dogs, 13, 30  
hotlines, 44

---

**i**

ice cream (homemade), 29  
internal temperatures, 17-19, 22, 23, 26,  
27, 29

---

**j**

jars, 42  
juice, 42

- I**  
labels, 8, 10  
lamb, 13, 19, 22  
leftover food, 11, 13, 19, 30, 34  
*Listeria monocytogenes*, 6  
luncheon meat, 13, 30
- 
- m**  
mail-order food, 40  
marinating, 31, 33  
microwaving, 16, 24, 26, 30, 31, 32, 38  
mold, 5
- 
- n**  
non-meat food products, 44
- 
- o**  
organic food, 10  
oven temperatures, 21, 22, 23, 26, 27
- 
- p**  
packaging, 8  
partial cooking (precooking), 32, 33  
pies, 29  
pizza, 13  
pork, 13, 19, 23  
poultry, 11, 13, 17, 19, 27  
power outages, 34, 41  
pregnancy, 2, 28  
preparation, 15, 16  
produce, 8, 11, 16, 44
- 
- q**  
quiche, 29
- 
- r**  
recalls, 43  
refreezing, 12, 16, 24  
refrigerating, 11, 13, 24, 25, 28, 29, 30  
refrigerators, 12, 16, 20, 24, 27, 28, 41, 42  
reheating, 30, 36  
restaurants, 44  
roaster ovens, 26  
roasting, 21, 25, 26  
roasts, 21
- 
- s**  
Safe Handling Instructions, 10  
safe minimum internal temperatures, 17, 19, 22, 23, 25, 26, 27, 32, 33, 36  
salads, 13  
*Salmonella*, 5, 7  
sanitizing, 15  
sausage, 13  
separate (foods), 8  
serving food, 36  
shelf-stable food, 11, 14  
shopping, 8  
slow cooking, 34  
smoking (meat and poultry), 6, 26, 33  
soup, 13  
spoilage bacteria, 4, 42  
standing times, 26, 31  
*Staphylococcus aureus*, 5, 7  
stew, 13  
storing food/storage, 11, 13, 14, 26, 28, 29, 30  
stuffing, 24, 25
- 
- t**  
take-out food (delivered food), 37  
temperature indicators (see *thermometers*)  
thawing, 12, 16, 24  
thermometers, 12, 17, 18, 25, 29, 32, 33, 37, 39, 46  
*Toxoplasma gondii*, 7  
transporting food, 9, 35  
*Trichinella spirallis*, 7  
turkey, 13, 24-26  
2-Hour Rule, 9, 28, 35, 36, 39
- 
- u**  
USDA Meat and Poultry  
Hotline, 44, back cover
- 
- v**  
veal, 13, 19, 22  
vegetables, 8, 11, 16, 44
- 
- w**  
washing (fruits/vegetables), 16  
washing poultry, 27



The U.S. Department of Agriculture (USDA) prohibits discrimination in all its programs and activities on the basis of race, color, national origin, age, disability, and where applicable, sex, marital status, familial status, parental status, religion, sexual orientation, genetic information, political beliefs, reprisal, or because all or part of an individual's income is derived from any public assistance program. (Not all prohibited bases apply to all programs.) Persons with disabilities who require alternative means for communication of program information (Braille, large print, audiotape, etc.) should contact USDA's TARGET Center at (202) 720-2600 (TTY (800) 877-8339). To file a complaint of discrimination, write to USDA, Director, Office of Civil Rights, 1400 Independence Avenue, S.W., Washington, D.C. 20250-9410, or call (800) 795-3272. USDA is an equal opportunity provider and employer.

February 2008

Slightly Revised March 2015



# Kitchen Companion

## For More Information

USDA Meat and Poultry Hotline

**1-888-MPHOTLINE**

(1-888-674-6854)

E-mail: [mph hotline.fsis@usda.gov](mailto:mph hotline.fsis@usda.gov)

“Ask Karen”

FSIS’s Web-based Automated Response System — Available 24/7

**[www.askkaren.gov](http://www.askkaren.gov)**

Food Safety and Inspection Service

**[www.fsis.usda.gov](http://www.fsis.usda.gov)**

Your Gateway to Food Safety Information

Provided by Government Agencies

**[www.FoodSafety.gov](http://www.FoodSafety.gov)**